

### Features

- Short-channel transistor with high S/C quality factor
- For low-noise, gain-controlled input stages up to 1 GHz

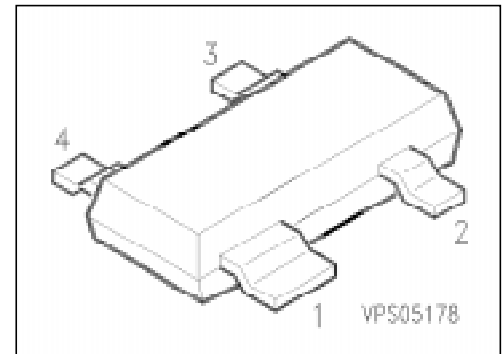

Type	Marking	Ordering Code (tape and reel)	Pin Configuration				Package <sup>1)</sup>
			1	2	3	4	
BF 998	MO	Q62702-F1129	S	D	G <sub>2</sub>	G <sub>1</sub>	SOT-143

### Maximum Ratings

Parameter	Symbol	Values	Unit
Drain-source voltage	$V_{DS}$	12	V
Drain current	$I_D$	30	mA
Gate 1/gate 2 peak source current	$\pm I_{G1/2SM}$	10	
Total power dissipation, $T_s < 76\text{ °C}$	$P_{tot}$	200	mW
Storage temperature range	$T_{stg}$	- 55 ... + 150	°C
Channel temperature	$T_{ch}$	150	

### Thermal Resistance

Junction - soldering point	$R_{th\ JS}$	< 370	K/W
----------------------------	--------------	-------	-----

<sup>1)</sup> For detailed information see chapter Package Outlines.

## Electrical Characteristics

at  $T_A = 25\text{ °C}$ , unless otherwise specified.

Parameter	Symbol	Values			Unit
		min.	typ.	max.	

## DC Characteristics

Drain-source breakdown voltage $I_D = 10\text{ }\mu\text{A}$ , $-V_{G1S} = -V_{G2S} = 4\text{ V}$	$V_{(BR)DS}$	12	–	–	V
Gate 1-source breakdown voltage $\pm I_{G1S} = 10\text{ mA}$ , $V_{G2S} = V_{DS} = 0$	$\pm V_{(BR)G1SS}$	8	–	12	
Gate 2-source breakdown voltage $\pm I_{G2S} = 10\text{ mA}$ , $V_{G1S} = V_{DS} = 0$	$\pm V_{(BR)G2SS}$	8	–	12	
Gate 1-source leakage current $\pm V_{G1S} = 5\text{ V}$ , $V_{G2S} = V_{DS} = 0$	$\pm I_{G1SS}$	–	–	50	nA
Gate 2-source leakage current $\pm V_{G2S} = 5\text{ V}$ , $V_{G1S} = V_{DS} = 0$	$\pm I_{G2SS}$	–	–	50	
Drain current $V_{DS} = 8\text{ V}$ , $V_{G1S} = 0$ , $V_{G2S} = 4\text{ V}$	$I_{DSS}$	2	–	18	mA
Gate 1-source pinch-off voltage $V_{DS} = 8\text{ V}$ , $V_{G2S} = 4\text{ V}$ , $I_D = 20\text{ }\mu\text{A}$	$-V_{G1S(p)}$	–	–	2.5	V
Gate 2-source pinch-off voltage $V_{DS} = 8\text{ V}$ , $V_{G1S} = 0$ , $I_D = 20\text{ }\mu\text{A}$	$-V_{G2S(p)}$	–	–	2	

## Electrical Characteristics

at  $T_A = 25\text{ °C}$ , unless otherwise specified.

Parameter	Symbol	Values			Unit
		min.	typ.	max.	

## AC Characteristics

Forward transconductance $V_{DS} = 8\text{ V}$ , $I_D = 10\text{ mA}$ , $V_{G2S} = 4\text{ V}$ $f = 1\text{ kHz}$	$g_{fs}$	–	24	–	mS
Gate 1 input capacitance $V_{DS} = 8\text{ V}$ , $I_D = 10\text{ mA}$ , $V_{G2S} = 4\text{ V}$ $f = 1\text{ MHz}$	$C_{g1ss}$	–	2.1	2.5	pF
Gate 2 input capacitance $V_{DS} = 8\text{ V}$ , $I_D = 10\text{ mA}$ , $V_{G2S} = 4\text{ V}$ $f = 1\text{ MHz}$	$C_{g2ss}$	–	1.2	–	
Reverse transfer capacitance $V_{DS} = 8\text{ V}$ , $I_D = 10\text{ mA}$ , $V_{G2S} = 4\text{ V}$ $f = 1\text{ MHz}$	$C_{dg1}$	–	25	–	fF
Output capacitance $V_{DS} = 8\text{ V}$ , $I_D = 10\text{ mA}$ , $V_{G2S} = 4\text{ V}$ $f = 1\text{ MHz}$	$C_{dss}$	–	1.05	–	pF
Power gain (test circuit 1) $V_{DS} = 8\text{ V}$ , $I_D = 10\text{ mA}$ , $f = 200\text{ MHz}$ , $G_G = 2\text{ mS}$ , $G_L = 0.5\text{ mS}$ , $V_{G2S} = 4\text{ V}$	$G_{ps}$	–	28	–	dB
Power gain (test circuit 2) $V_{DS} = 8\text{ V}$ , $I_D = 10\text{ mA}$ , $f = 800\text{ MHz}$ , $G_G = 3.3\text{ mS}$ , $G_L = 1\text{ mS}$ , $V_{G2S} = 4\text{ V}$	$G_{ps}$	–	20	–	
Noise figure (test circuit 1) $V_{DS} = 8\text{ V}$ , $I_D = 10\text{ mA}$ , $f = 200\text{ MHz}$ , $G_G = 2\text{ mS}$ , $G_L = 0.5\text{ mS}$ , $V_{G2S} = 4\text{ V}$	$F$	–	0.6	–	dB
Noise figure (test circuit 2) $V_{DS} = 8\text{ V}$ , $I_D = 10\text{ mA}$ , $f = 800\text{ MHz}$ , $G_G = 3.3\text{ mS}$ , $G_L = 1\text{ mS}$ , $V_{G2S} = 4\text{ V}$	$F$	–	1	–	
Control range (test circuit 2) $V_{DS} = 8\text{ V}$ , $V_{G2S} = 4 \dots - 2\text{ V}$ $f = 800\text{ MHz}$	$\Delta G_{ps}$	40	–	–	

**Total power dissipation  $P_{tot} = f(T_A)$**

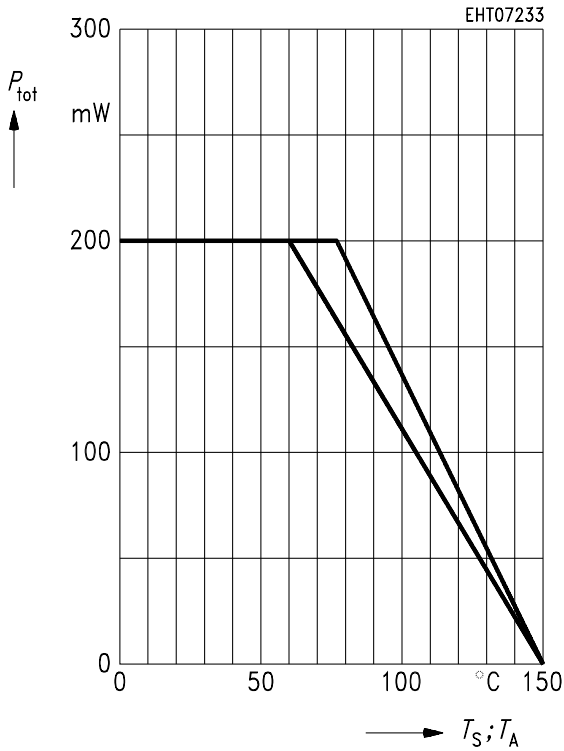

**Output characteristics  $I_D = f(V_{DS})$**

$V_{G2S} = 4 \text{ V}$

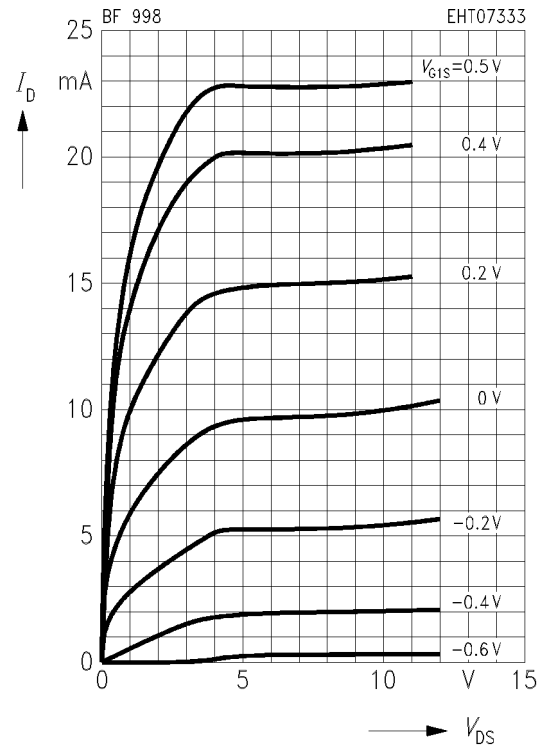

**Gate 1 forward transconductance  $g_{fs1} = f(V_{G1S})$**

$g_{fs1} = f(V_{G1S})$

$V_{DS} = 8 \text{ V}, I_{DSS} = 10 \text{ mA}, f = 1 \text{ kHz}$

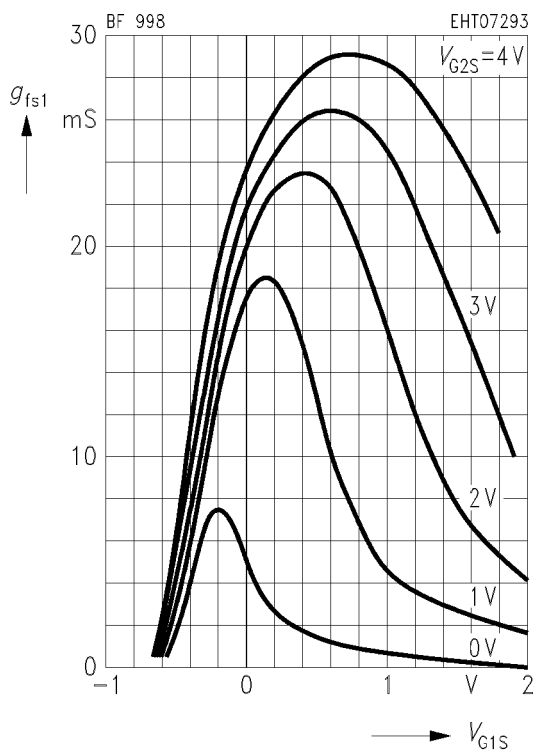

**Gate 1 forward transconductance  $g_{fs1} = f(V_{G2S})$**

$g_{fs1} = f(V_{G2S})$

$V_{DS} = 8 \text{ V}, I_{DSS} = 10 \text{ mA}, f = 1 \text{ kHz}$

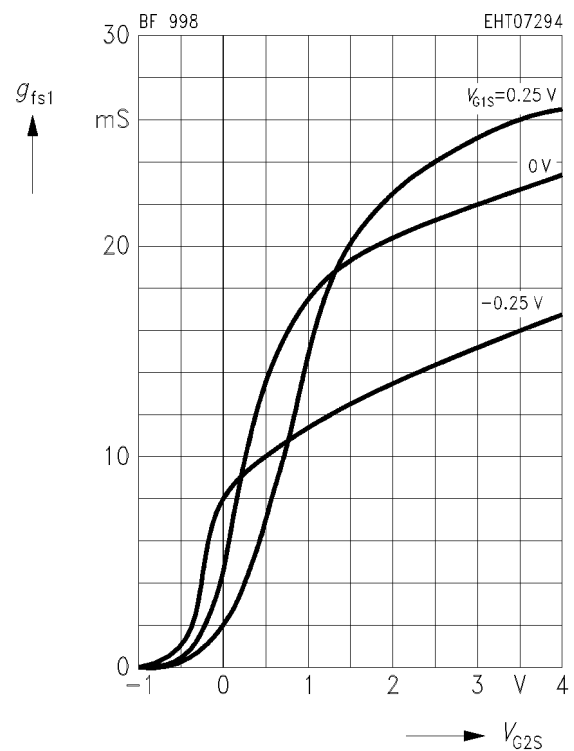

**Gate 1 forward transconductance**

$g_{fs1} = f(I_D)$

$V_{DS} = 8\text{ V}, I_{DSS} = 10\text{ mA}, f = 1\text{ kHz}$

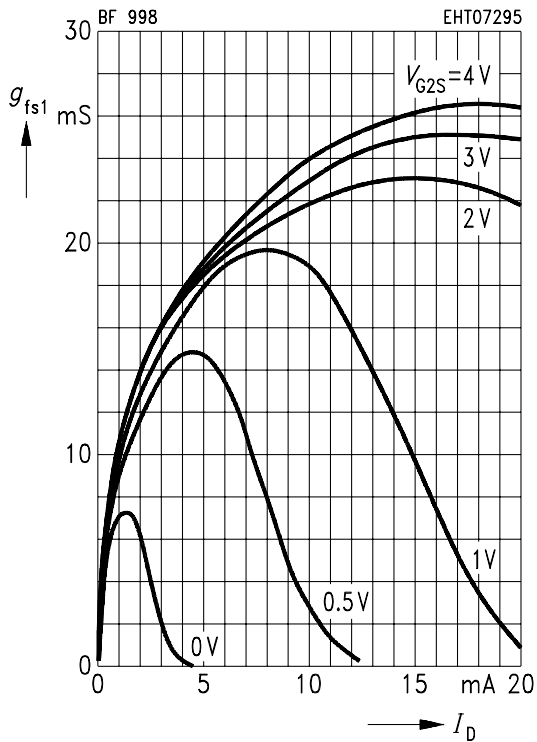

**Gate 1 input capacitance  $C_{g1ss} = f(V_{G1S})$**

$V_{G2S} = 4\text{ V}, V_{DS} = 8\text{ V}, I_{DSS} = 10\text{ mA}, f = 1\text{ MHz}$

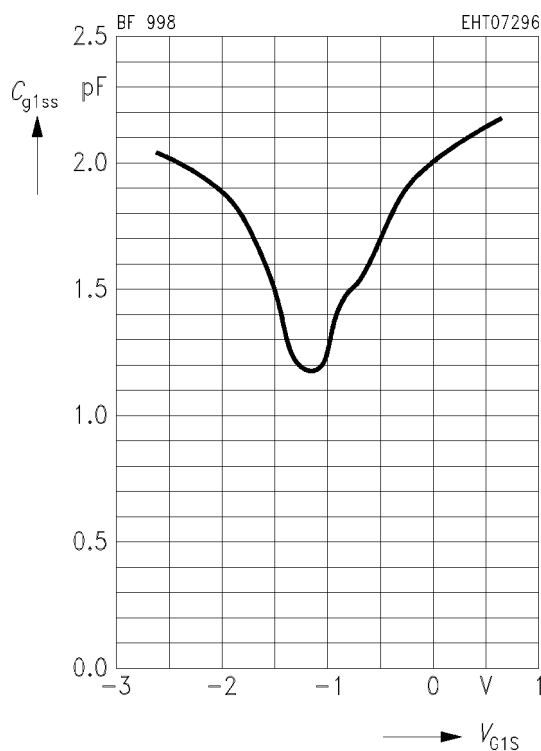

**Gate 2 input capacitance  $C_{g2ss} = f(V_{G2S})$**

$V_{G1S} = 0\text{ V}, V_{DS} = 8\text{ V}$

$I_{DSS} = 10\text{ mA}, f = 1\text{ MHz}$

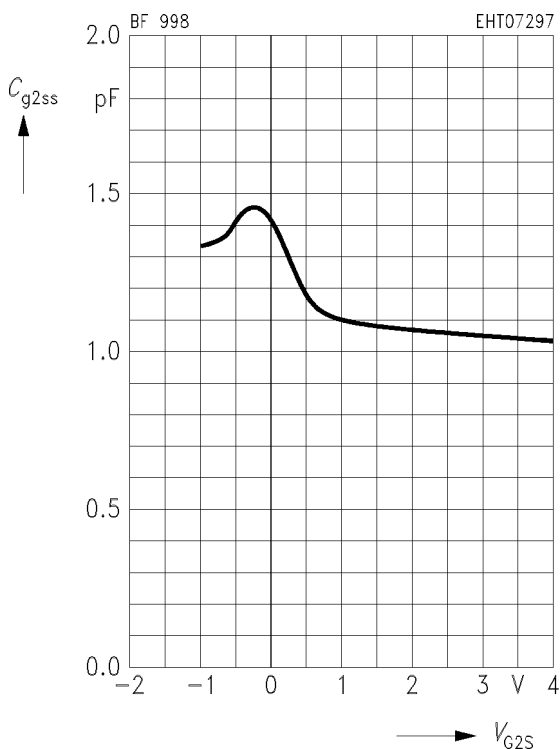

**Output capacitance  $C_{dss} = f(V_{DS})$**

$V_{G1S} = 0\text{ V}, V_{G2S} = 4\text{ V}$

$I_{DSS} = 10\text{ mA}, f = 1\text{ MHz}$

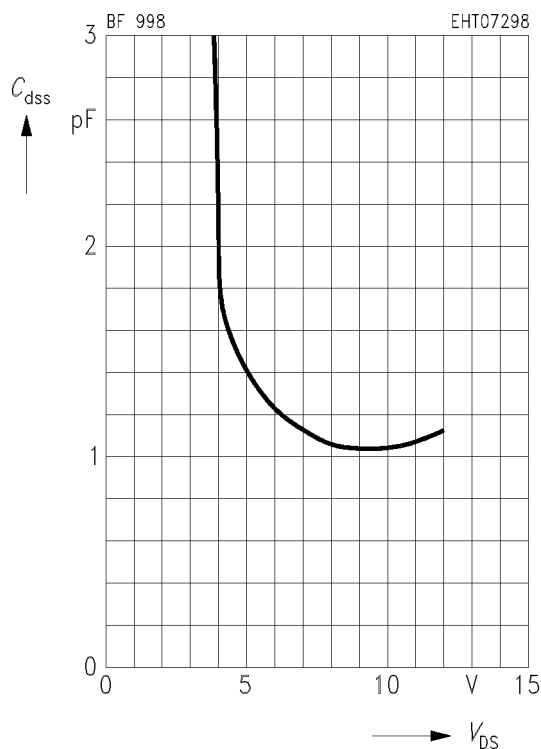

**Drain current  $I_D = f(V_{G1S})$**

$V_{DS} = 8\text{ V}$

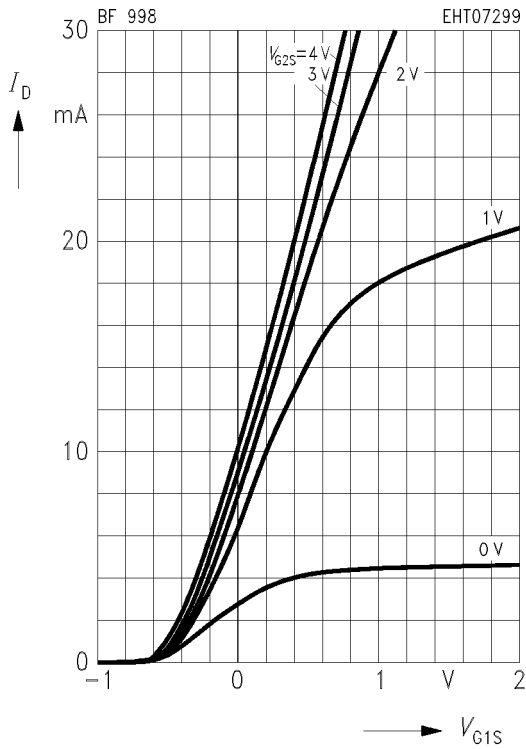

**Power gain  $G_{ps} = f(V_{G2S})$**

$V_{DS} = 8\text{ V}$ ,  $V_{G1S} = 0$ ,  $I_{DSS} = 10\text{ mA}$ ,  
 $f = 200\text{ MHz}$  (see test circuit 1)

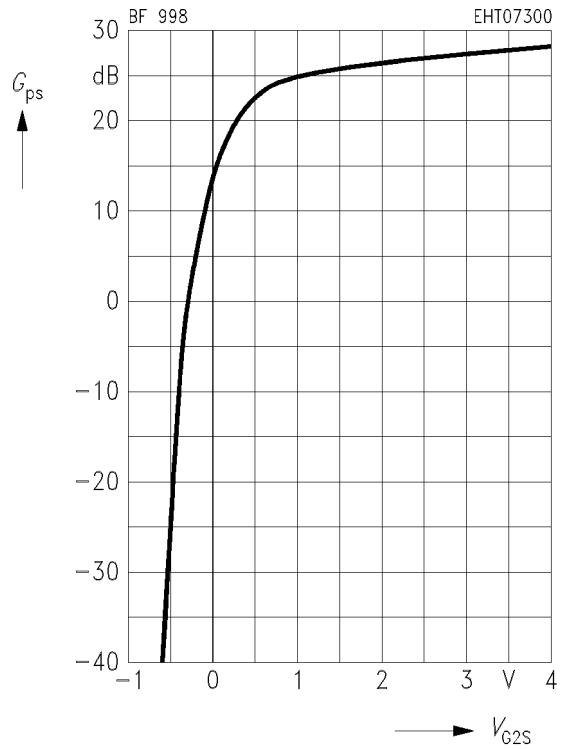

**Noise figure  $F = f(V_{G2S})$**

$V_{DS} = 8\text{ V}$ ,  $V_{G1S} = 0$ ,  $I_{DSS} = 10\text{ mA}$ ,  
 $f = 200\text{ MHz}$  (see test circuit 1)

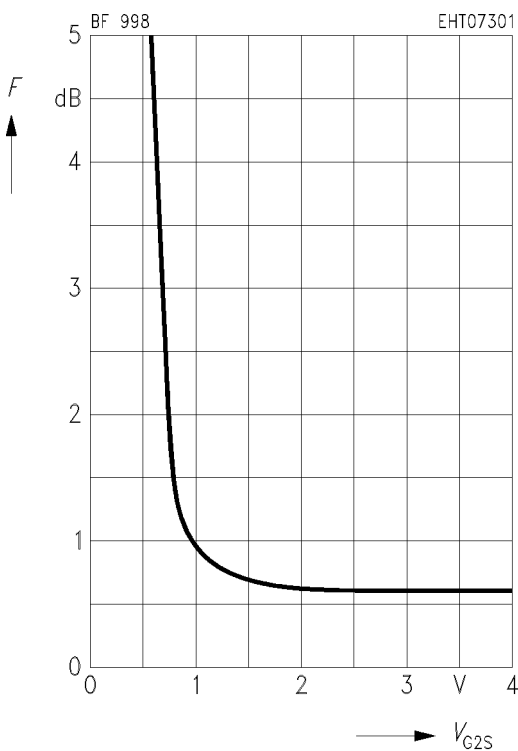

**Power gain  $G_{ps} = f(V_{G2S})$**

$V_{DS} = 8\text{ V}$ ,  $V_{G1S} = 0$ ,  $I_{DSS} = 10\text{ mA}$ ,  
 $f = 800\text{ MHz}$  (see test circuit 2)

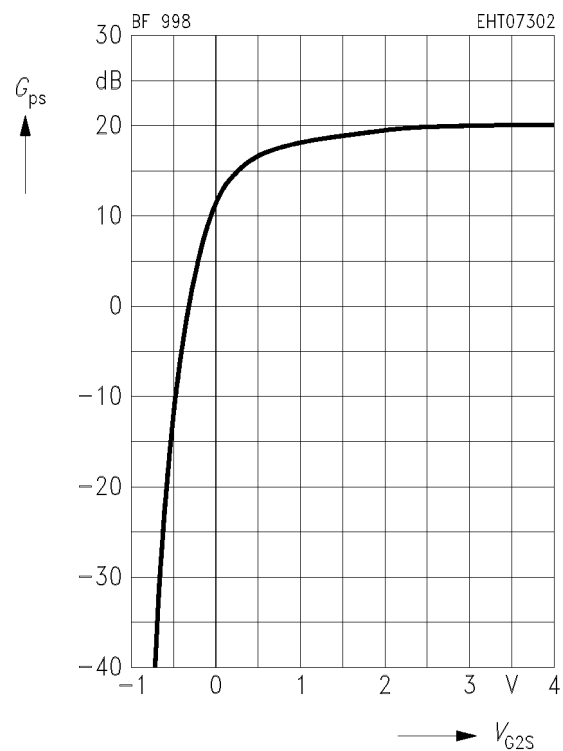

**Noise figure  $F = f(V_{G2S})$**

$V_{DS} = 8\text{ V}$ ,  $V_{G1S} = 0$ ,  $I_{DSS} = 10\text{ mA}$ ,  
 $f = 800\text{ MHz}$  (see test circuit 2)

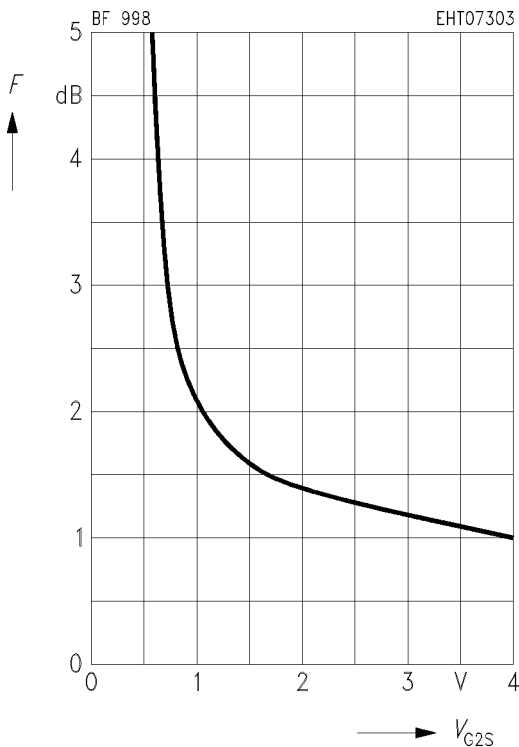

**Gate 1 input admittance  $y_{11s}$**

$V_{DS} = 8\text{ V}$ ,  $V_{G2S} = 4\text{ V}$ ,  $V_{G1S} = 0$ ,  
 $I_{DSS} = 10\text{ mA}$  (common-source)

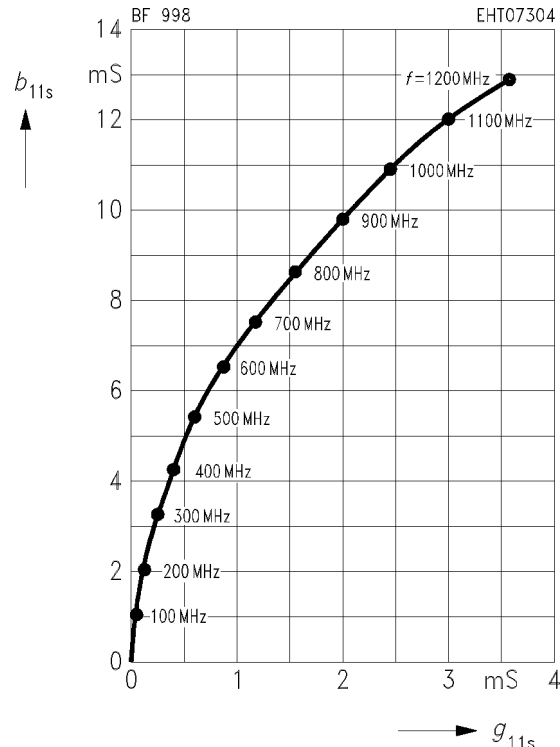

**Gate 1 forward transfer admittance  $y_{21s}$**

$V_{DS} = 8\text{ V}$ ,  $V_{G2S} = 4\text{ V}$ ,  $V_{G1S} = 0$ ,  
 $I_{DSS} = 10\text{ mA}$  (common-source)

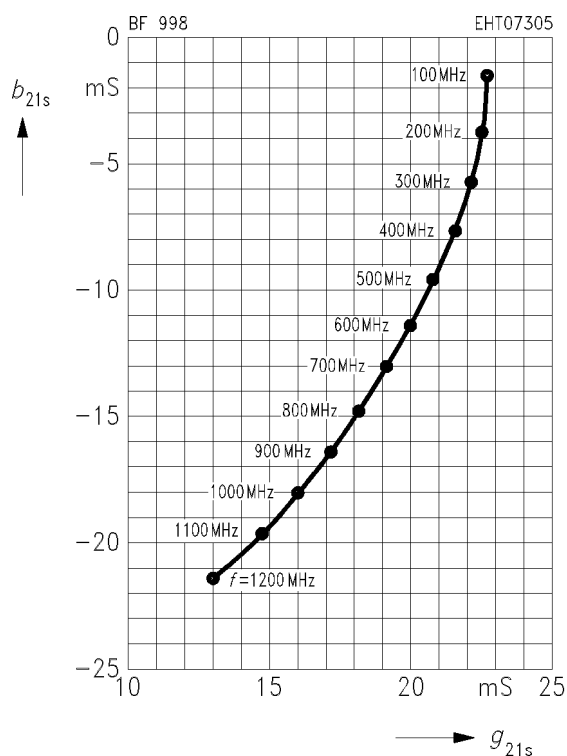

**Output admittance  $y_{22s}$**

$V_{DS} = 8\text{ V}$ ,  $V_{G2S} = 4\text{ V}$ ,  $V_{G1S} = 0$ ,  
 $I_{DSS} = 10\text{ mA}$  (common-source)

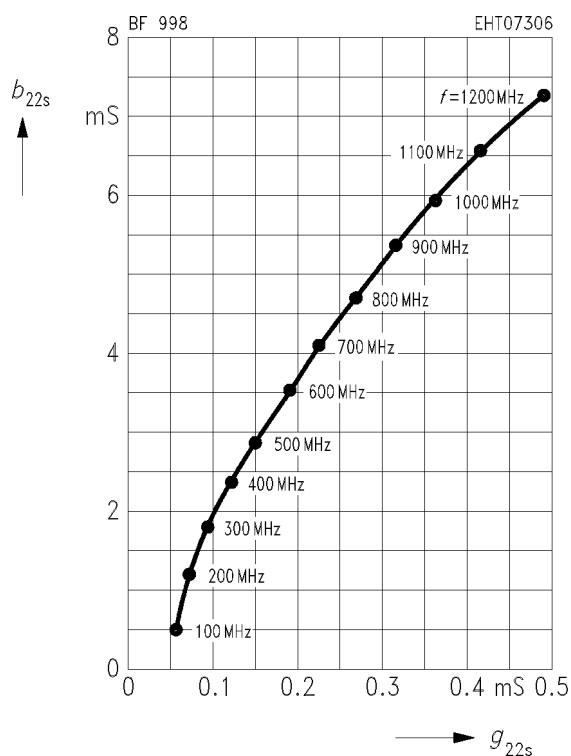

**Test circuit 1 for power gain and noise figure**

$f = 200 \text{ MHz}$ ,  $G_G = 2 \text{ mS}$ ,  $G_L = 0.5 \text{ mS}$

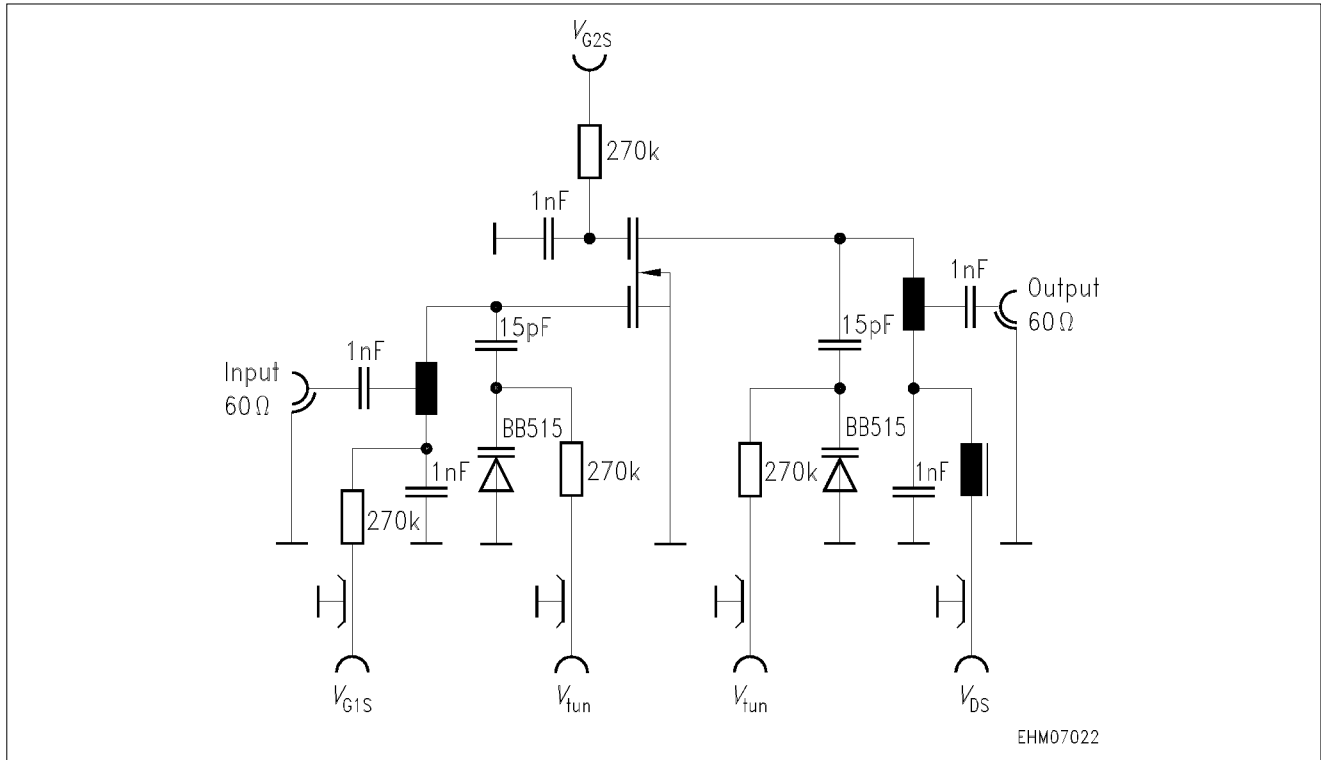

**Test circuit 2 for power gain and noise figure**

$f = 800 \text{ MHz}$ ,  $G_G = 3.3 \text{ mS}$ ,  $G_L = 1 \text{ mS}$

