

RF AMP. FOR UHF TV TUNER
 N-CHANNEL GaAs DUAL-GATE MES FIFLD-EFFECT TRANSISTOR
 4 PIN SMALL MINI MOLD

FEATURES

- Suitable for use as RF amplifier in UHF TV tuner.
- Low C_{rss} : 0.02 pF TYP.
- High G_{ps} : 20 dB TYP.
- Low NF : 1.1 dB TYP.
- 4 PIN SMALL MINI MOLD PACKAGE

ABSOLUTE MAXIMUM RATINGS ($T_A = 25\text{ }^\circ\text{C}$)

Drain to Source Voltage	V_{DSX}	13	V
Gate1 to Source Voltage	V_{G1S}	-4.5	V
Gate2 to Source Voltage	V_{G2S}	-4.5	V
Drain Current	I_D	40	mA
Total Power Dissipation	P_T	120	mW
Channel Temperature	T_{ch}	125	$^\circ\text{C}$
Storage Temperature	T_{stg}	-55 to +125	$^\circ\text{C}$

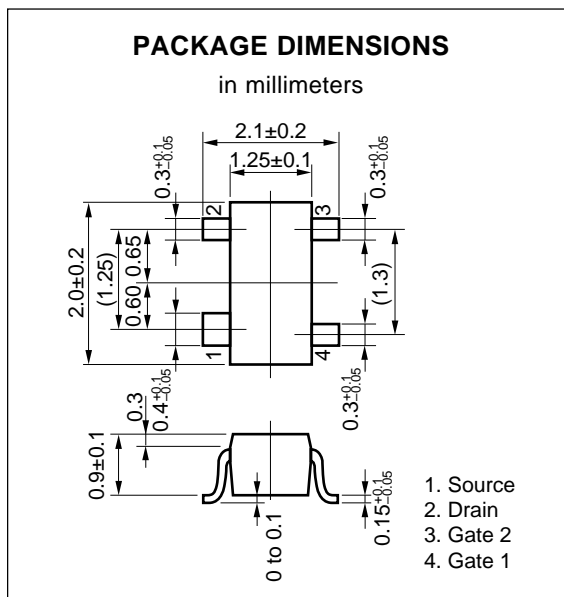

ELECTRICAL CHARACTERISTICS ($T_A = 25\text{ }^\circ\text{C}$)

CHARACTERISTIC	SYMBOL	MIN.	TYP.	MAX.	UNIT	TEST CONDITIONS
Drain Current	I_{DSX}			10	μA	$V_{DS} = 13\text{ V}, V_{G1S} = -4\text{ V}, V_{G2S} = 0$
Drain Current	I_{DSS}	5	20	40	mA	$V_{DS} = 5\text{ V}, V_{G2S} = 0, V_{G1S} = 0$
Gate1 to Source Cutoff Voltage	$V_{G1S(off)}$			-3.5	V	$V_{DS} = 5\text{ V}, V_{G2S} = 0, I_D = 100\text{ }\mu\text{A}$
Gate2 to Source Cutoff Voltage	$V_{G2S(off)}$			-3.5	V	$V_{DS} = 5\text{ V}, V_{G1S} = 0, I_D = 100\text{ }\mu\text{A}$
Gate1 Reverse Current	I_{G1SS}			10	μA	$V_{DS} = 0, V_{G1S} = -4\text{ V}, V_{G2S} = 0$
Gate2 Reverse Current	I_{G2SS}			10	μA	$V_{DS} = 0, V_{G2S} = -4\text{ V}, V_{G1S} = 0$
Forward Transfer Admittance	$ y_{fs} $	18	25	35	ms	$V_{DS} = 5\text{ V}, V_{G2S} = 1\text{ V}, I_D = 10\text{ mA}$ $f = 1.0\text{ kHz}$
Input Capacitance	C_{iss}	0.5	1.0	1.5	pF	$V_{DS} = 5\text{ V}, V_{G2S} = 1\text{ V}, I_D = 10\text{ mA}$ $f = 1\text{ MHz}$
Reverse Transfer Capacitance	C_{rss}		0.02	0.03	pF	
Power Gain	G_{PS}	16.0	20.0		dB	$V_{DS} = 5\text{ V}, V_{G2S} = 1\text{ V}, I_D = 10\text{ mA}$
Noise Figure	NF		1.1	2.5	dB	$f = 900\text{ MHz}$

I_{DSS} Classification

Unit: mA

Class	U71	U72	U73	U74
Marking	U71	U72	U73	U74
I_{DSS}	5 to 15	10 to 25	20 to 35	30 to 40

TYPICAL CHARACTERISTICS (T_A = 25 °C)

TOTAL POWER DISSIPATION vs. AMBIENT TEMPERATURE

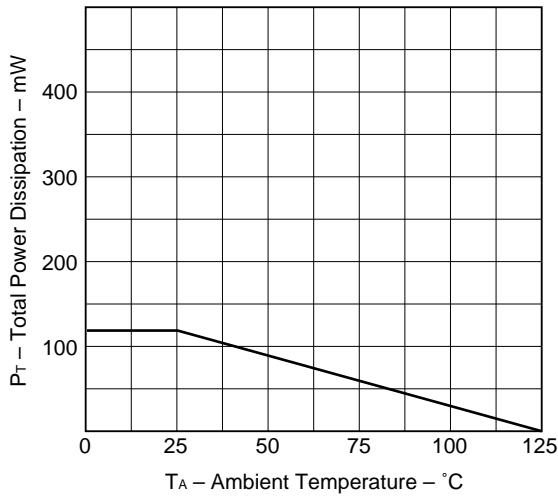

DRAIN CURRENT vs. GATE1 TO SOURCE VOLTAGE

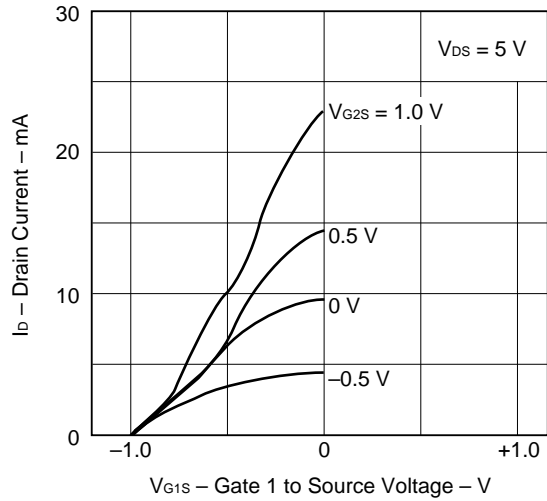

FORWARD TRANSFER ADMITTANCE vs. GATE1 TO SOURCE VOLTAGE

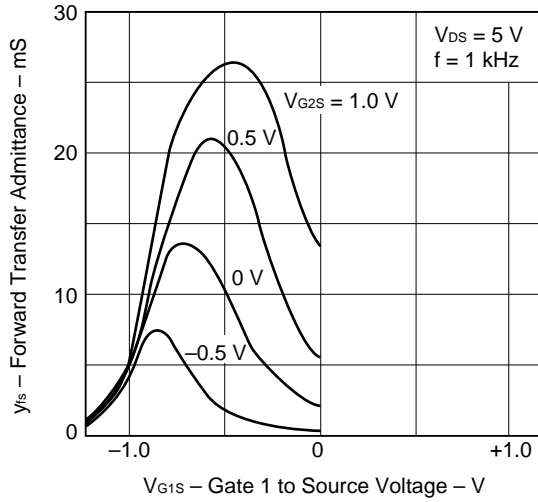

FORWARD TRANSFER ADMITTANCE vs. DRAIN CURRENT

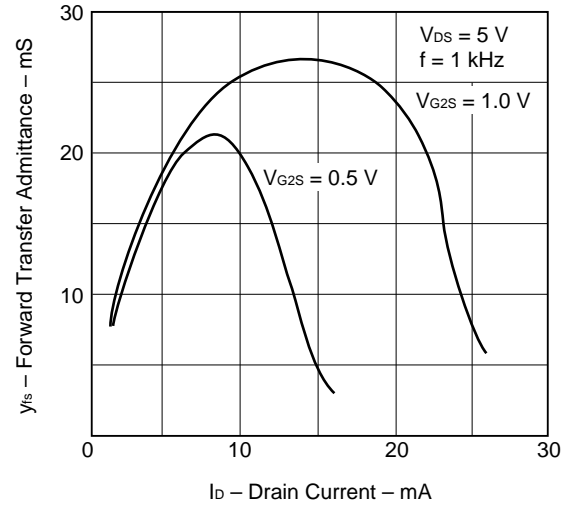

INPUT CAPACITANCE vs. GATE2 TO SOURCE VOLTAGE

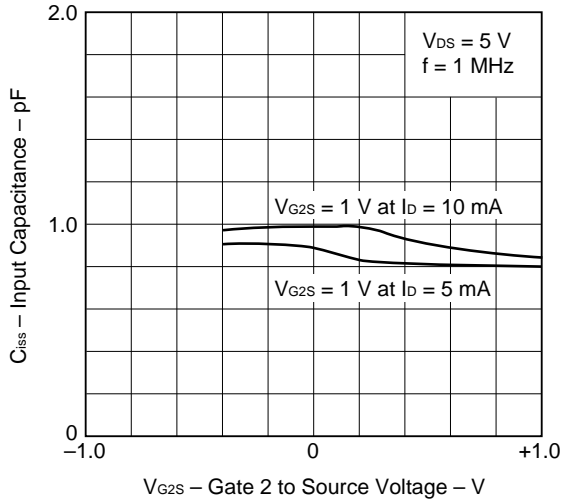

POWER GAIN AND NOISE FIGURE vs. GATE2 TO SOURCE VOLTAGE

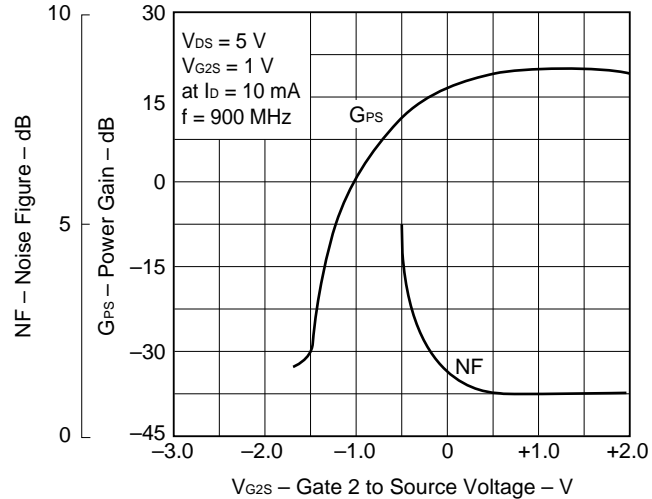

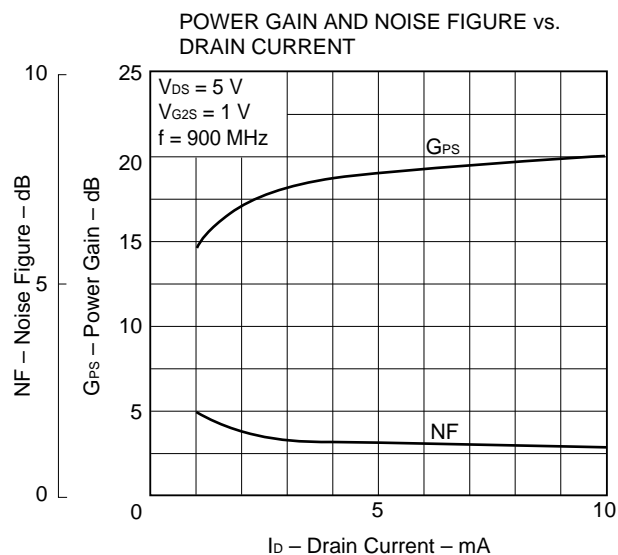
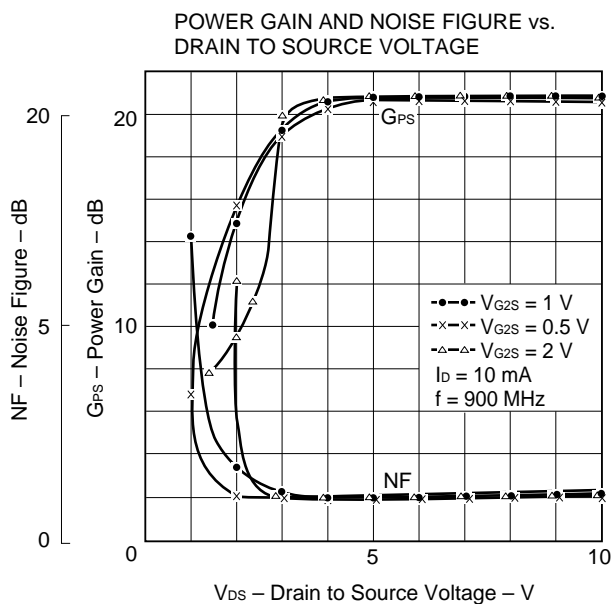

S-PARAMETER (V_{DS} = 5 V, V_{G2S} = 1 V, I_D = 10 mA)

FREQUENCY MHz	S11		S21		S12		S22	
	MAG	ANG	MAG	ANG	MAG	ANG	MAG	ANG
100.0000	0.999	-3.3	2.359	177.2	0.006	-122.3	0.969	-1.3
200.0000	1.000	-7.2	2.389	169.3	0.004	123.0	0.981	-2.9
300.0000	0.998	-9.3	2.313	164.4	0.000	-145.0	0.979	-3.3
400.0000	0.974	-13.4	2.233	160.0	0.004	79.2	0.967	5.6
500.0000	1.005	-15.7	2.420	158.4	0.007	29.7	0.999	-5.8
600.0000	0.942	-19.1	2.300	150.0	0.003	65.0	0.958	-7.7
700.0000	0.968	-22.2	2.332	145.5	0.004	45.5	0.997	-8.5
800.0000	0.920	-25.2	2.229	141.5	0.008	80.1	0.957	-9.4
900.0000	0.952	28.9	2.447	136.8	0.004	8.3	0.999	-12.5
1000.0000	0.898	-29.4	2.303	131.1	0.001	50.9	0.968	-11.1
1100.0000	0.915	-35.1	2.348	125.8	0.004	71.4	0.984	-14.8
1200.0000	0.879	-35.2	2.367	123.5	0.000	91.1	0.989	-13.0

900 MHz GPs AND NF TEST CIRCUIT

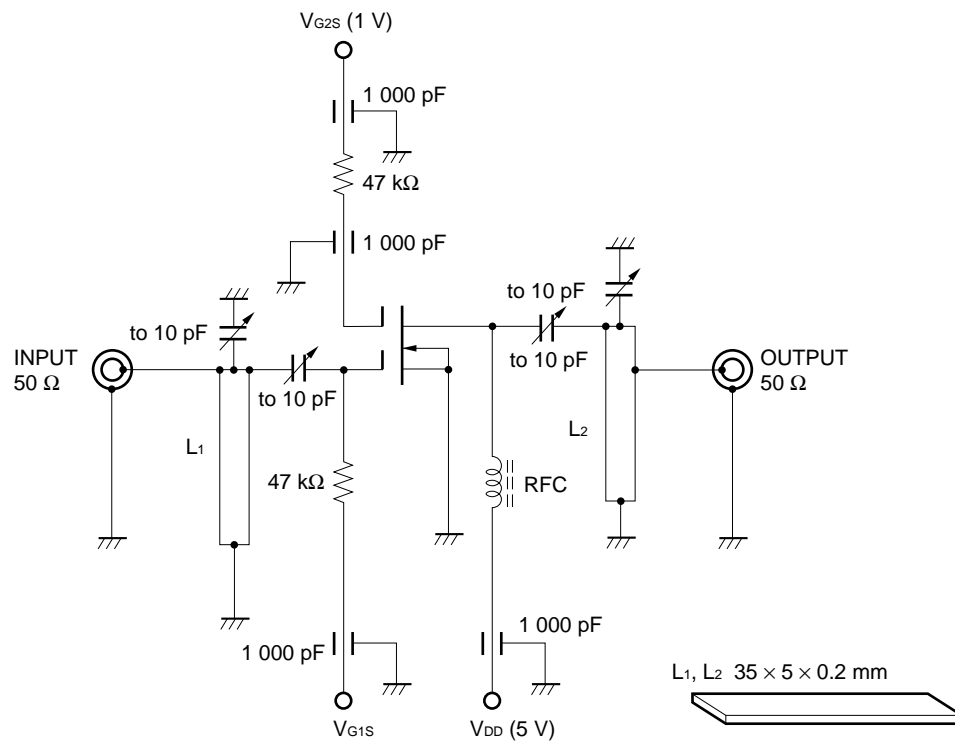

$V_{DS} = 5 \text{ V}$, $V_{G2S} = 1 \text{ V}$, $I_D = 10 \text{ mA}$

[MEMO]

No part of this document may be copied or reproduced in any form or by any means without the prior written consent of NEC Corporation. NEC Corporation assumes no responsibility for any errors which may appear in this document.

NEC Corporation does not assume any liability for infringement of patents, copyrights or other intellectual property rights of third parties by or arising from use of a device described herein or any other liability arising from use of such device. No license, either express, implied or otherwise, is granted under any patents, copyrights or other intellectual property rights of NEC Corporation or others.

While NEC Corporation has been making continuous effort to enhance the reliability of its semiconductor devices, the possibility of defects cannot be eliminated entirely. To minimize risks of damage or injury to persons or property arising from a defect in an NEC semiconductor device, customer must incorporate sufficient safety measures in its design, such as redundancy, fire-containment, and anti-failure features.

NEC devices are classified into the following three quality grades:

"Standard", "Special", and "Specific". The Specific quality grade applies only to devices developed based on a customer designated "quality assurance program" for a specific application. The recommended applications of a device depend on its quality grade, as indicated below. Customers must check the quality grade of each device before using it in a particular application.

Standard: Computers, office equipment, communications equipment, test and measurement equipment, audio and visual equipment, home electronic appliances, machine tools, personal electronic equipment and industrial robots

Special: Transportation equipment (automobiles, trains, ships, etc.), traffic control systems, anti-disaster systems, anti-crime systems, safety equipment and medical equipment (not specifically designed for life support)

Specific: Aircrafts, aerospace equipment, submersible repeaters, nuclear reactor control systems, life support systems or medical equipment for life support, etc.

The quality grade of NEC devices in "Standard" unless otherwise specified in NEC's Data Sheets or Data Books. If customers intend to use NEC devices for applications other than those specified for Standard quality grade, they should contact NEC Sales Representative in advance.

Anti-radioactive design is not implemented in this product.